

Moxa AirWorks AWK-4121

Quick Installation Guide

Third Edition, July 2009



© 2009 Moxa Inc. All rights reserved.
Reproduction without permission is prohibited.

Notes for the Reader



WARNING

Indicates that death or personal injury may occur if proper precautions are not taken.



ATTENTION

Indicates that possible damage to this product or your property may result if proper precautions are not taken.



NOTE

Highlights important information related to this product.

Package Checklist

Moxa's AWK-4121 is shipped with the following items. If any of these items is missing or damaged, please contact your customer service representative for assistance.

- 1 AWK-4121
- 2 Antennas (5dBi, N-type (male), 2.4GHz)
- 1 Quick Installation Guide
- 1 Software CD
- 1 Moxa Product Warranty Booklet
- 1 Accessory Pack (including wall-mounting kit, screws and RJ45 field plug)



NOTE

The above items come with the AWK-4121 standard version. The package contents may vary in a different customized version.

Installation

Before installing the AWK-4121, make sure that all items in the Package Checklist are in the box. In addition, you will need access to a notebook computer or PC equipped with an Ethernet port. The AWK-4121 has a default IP address, user name and password that you must use when resetting or connecting to your AWK-4121 device.

Default IP address: **192.168.127.253**

User name: **admin**

Password: **root**

Please read “**Chapter2 Getting Started**” in AWK-4121 User's Manual for more details about installation and configuration.



ATTENTION

For security reasons, we strongly recommend changing the password. To do so, go to **Maintenance** → **Password**, and then follow the on-screen instructions.



NOTE

To make the change effective, you must save the change and then click **Restart** → **Save** and **Restart** button to apply all changes.

Panel Layout of the AWK-4121

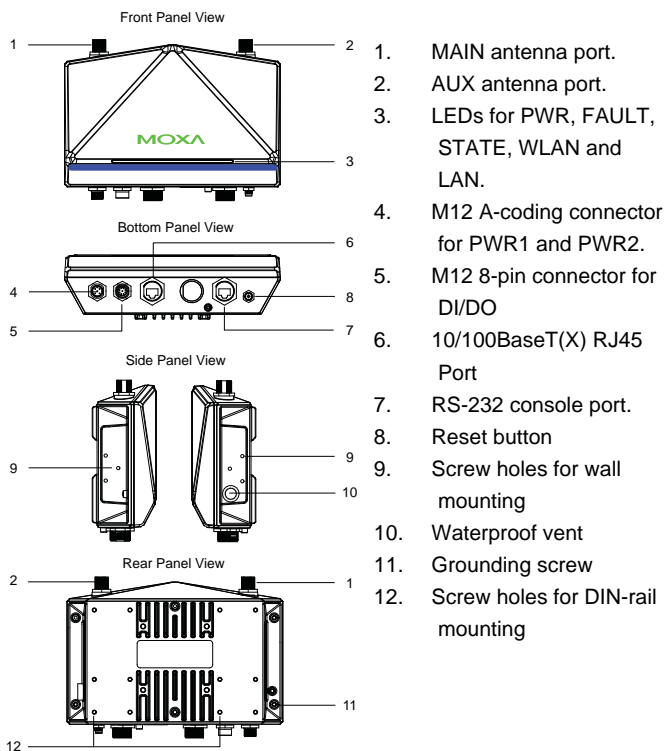

ATTENTION

Please **DO NOT** open or remove the vent **10**. The warranty will be invalid if the seal is removed.

All exposed connectors, including **1, 2, 4 - 8**, should be tightly covered by suitable caps when they are not in use.

Dimensions (unit = mm)

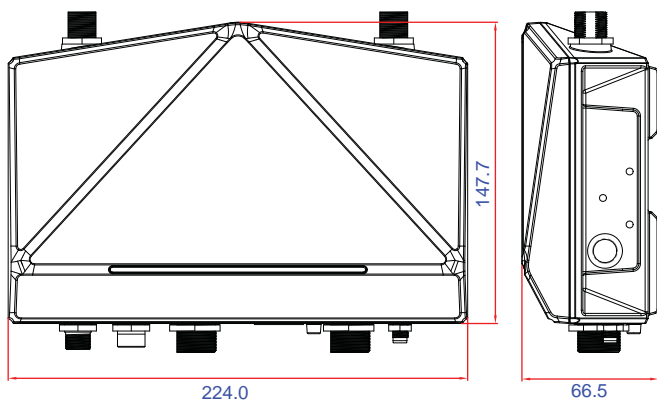

Wall Mounting

In most applications, wall mount provides an easier installation. You will find it quite easy to mount AWK-4121 on the wall, as illustrated below.

STEP 1:

Attach the wall-mounting kit with **M4** screws, as shown in the diagram below.

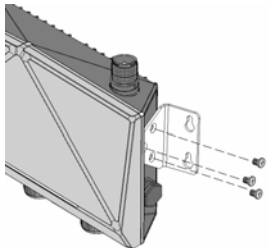

STEP 2:

Mounting the AWK-4121 on the wall requires 4 screws. Use the AWK-4121 device, with wall-mounting kit attached, as a guide to mark the correct locations of the 4 screws. The heads of the screws are recommended to be between **5.5mm** and **8.5 mm** in diameter, and the shafts should not be more than 5.0 mm in diameter, as shown in the figure.

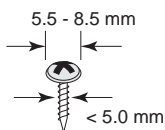

Do not screw the screws all the way in to the wall—leave a space of about 2 mm to allow room for sliding the wall-mounting kit between the wall and the screws.



ATTENTION

You can test the screw head and shank size by inserting the screw into one of the keyhole shaped apertures of the wall mounting plates before it is screwed into the wall.

STEP 3:

Once the screws are fixed into the wall, insert the four screw heads through the large opening of the keyhole-shaped apertures, and then slide the AWK-4121 downwards, as indicated to the right. Tighten the four screws for added stability.

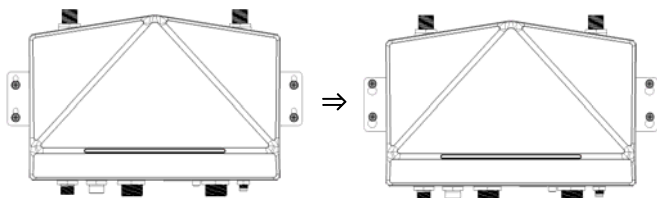

ATTENTION

To avoid environmental vibration or shock, you can consider a robust installation with four bigger screws, which the shafts are between 7.0 mm and 8.5 mm in diameter, and fix the AWK-4121 onto wall directly and tightly.

DIN-Rail Mounting (Optional)

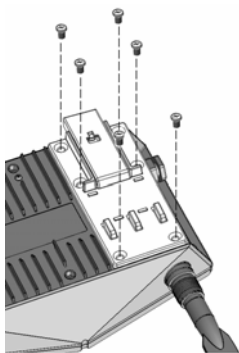

The **DK-DC50131** die-cast metal kit can be bought separately, and enable easy and robust installation for the AWK-4121. A pair of DK-DC50131s is needed for DIN-Rail mounting. To install the DIN-Rail mounting kits, tightly attach the two DIN-Rail mounting kits on the rear panel of AWK-4121 with 12 screws. (6 screws for each kit)

To Install

STEP 1:

Use the recessed button on the spring-loaded bracket to lock it into position.

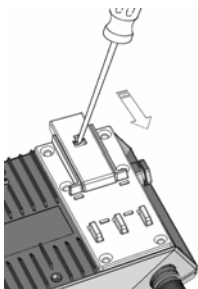

STEP 2:

Insert the top of the DIN-Rail into the slot just below the upper hook of the DIN-Rail mounting kit. Push the AWK-4121 toward the DIN-Rail until the DIN-Rail attachment bracket snaps into place.

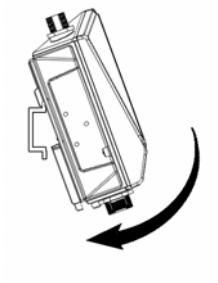

To Release

STEP 1:

Pull out the two spring-loaded brackets from the bottom until they are fixed in the “release” position.

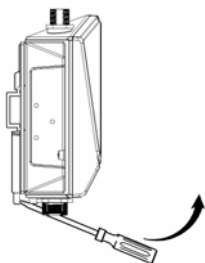

STEP 2:

Pull the AWK-4121 out and upward.

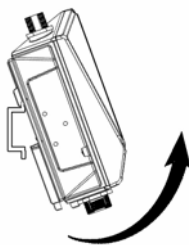

Wiring Requirements



WARNING

Safety First!

Be sure to disconnect the power cord before installing and/or wiring your Moxa AWK-4121.

Calculate the maximum possible current in each power wire and common wire. Observe all electrical codes dictating the maximum current allowable for each wire size. If the current goes above the maximum ratings, the wiring could overheat, causing serious damage to your equipment.

You should also pay attention to the following items:

- Use separate paths to route wiring for power and devices. If power wiring and device wiring paths must cross, make sure the wires are perpendicular at the intersection point.
NOTE: Do not run signal or communications wiring and power wiring in the same wire conduit. To avoid interference, wires with different signal characteristics should be routed separately.
- You can use the type of signal transmitted through a wire to determine which wires should be kept separate. The rule of thumb is that wiring with similar electrical characteristics can be bundled together.
- Keep input wiring and output wiring separate.
- It is strongly advised that you label wiring to all devices in the system when necessary.

Grounding Moxa AWK-4121

Grounding and wire routing help limit the effects of noise due to electromagnetic interference (EMI). Run the ground connection from the ground screw to the grounding surface prior to connecting devices.



ATTENTION

This product is intended to be mounted to a well-grounded mounting surface, such as a metal panel. There must be no potential difference between two ground potentials, otherwise there is a risk that the device could be destroyed.

Wiring the Redundant Power Inputs

The AWK-4121 must be connected to a power-over-Ethernet (PoE) IEEE 802.3af compliant power source or an IEC60950 compliant limited power source. When AWK-4121 is powered via DC power, the M12 A-coding connector on the bottom panel is used for the AWK-4121's two redundant inputs. The pin assignment is shown below:

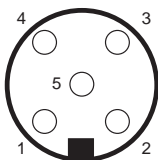

Pin	Power Input
1	V1+
2	V2+
3	V1-
4	V2-
5	GND



ATTENTION

This product is intended to be supplied by a Listed Power Unit marked “Class 2” or “LPS” and rated O/P: 12 to 48 VDC, minimum 6 W (12 V/0.494 A to 48V/0.121 A, 25°C). Make sure External Power Adaptor (includes power cords and plug assemblies) provided with the unit is certified and suitable for use in your country.

Before connecting the AWK-4121 to the DC power inputs, make sure the DC power source voltage is stable.

Wiring the Digital Inputs and Relay Contact (Digital Output)

The AWK-4121 has two sets of digital input—DI1 and DI2. Each DI comprises two contacts of the 8-pin M12 connector on the AWK-4121's bottom panel. These two digital inputs can be connected to digital-output-enabled sensors for on-site status monitoring.

The AWK-4121 also has one relay output, which consists of the two contacts. These relay contacts are used to detect user-configured events. The two wires attached to the Relay contacts form an open circuit when a user-configured event is triggered. If a user-configured event does not occur, the Relay circuit will be closed.

A field-installable plug, **M12A-8PMM-IP68**, is recommended for connecting the AWK-4121's DIs and relay.

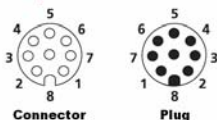
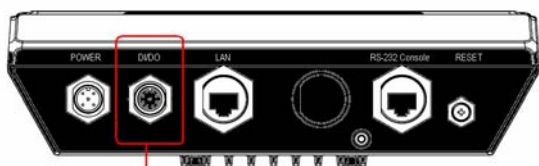

Pin	Signal
1	Relay
2	
3	DI1 I1
4	DI1 COM_1
5	DI2 I2
6	DI2 COM_2
7	Reserved
8	

Communication Connections

10/100BaseT(X) Ethernet Port Connection

The 10/100BaseT(X) ports located on the AWK-4121's bottom panel are used to connect to Ethernet-enabled devices.

Below we show pinouts for both MDI (NIC-type) ports and MDI-X (HUB/Switch-type) ports.

MDI Port Pinouts

Pin	Signal
1	Tx+
2	Tx-
3	Rx+
6	Rx-

MDI-X Port Pinouts

Pin	Signal
1	Rx+
2	Rx-
3	Tx+
6	Tx-

8-pin RJ45

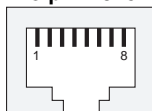

RS-232 Connection

The AWK-4121 has one RS-232 (8-pin RJ45) console port located on the bottom panel. Use either an RJ45-to-DB9 or RJ45-to-DB25 cable to connect the Moxa AWK-4121's console port to your PC's COM port. You may then use a console terminal program to access the AWK-4121 for console configuration.

Console Pinouts for 10-pin or 8-pin RJ45

10-Pin	Description	8-Pin
1	-----	
2	DSR	1
3	RTS	2
4	GND	3
5	TxD	4
6	RxD	5
7	DCD	6
8	CTS	7
9	DTR	8
10	-----	

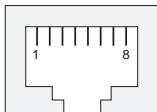

- NOTE**
1. The pin numbers for male DB9 and DB25 connectors, and hole numbers for female DB9 and DB25 connectors are labeled on the connector. However, the numbers are typically quite small, so you may need to use a magnifying glass to see the numbers clearly.
 2. The pin numbers for both 8-pin and 10-pin RJ45 connectors (and ports) are typically not labeled on the connector (or port). Refer to the Pinout diagram above to see how RJ45 pins are numbered.



ATTENTION

To ensure the IP67-rated connectivity, you must use a waterproof housing during any communication activities. An IP67-rated field installable plug, which is attached in AWK-4121's accessory pack, may be needed in this case. The installation guide is shown below:

Waterproof RJ45 Plug (Optional)

Dimensions (unit: mm)

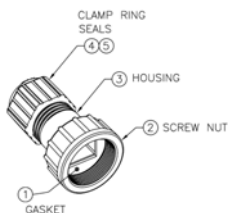
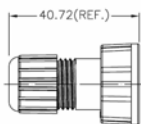
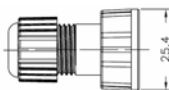

Installation

STEP 1:

Attach the gasket ① to the housing ③

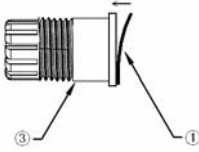

STEP 2:

Insert the cable (ex. CAT5e) through the clamp ring ④, screw nut ②, seal ⑤ and housing ③, as follows:

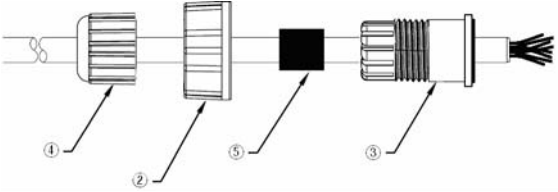

STEP 3:

Crimp the modular RJ plug to the cable; (NOTE: the snagless cover shield and strain-relief boot are not recommended.) Then, assemble the seals and the housing (③ and ⑤).

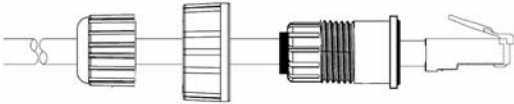

STEP 4:

Tightly screw the clamp ring ④ to the housing and check to make sure that the plug is securely fastened.

(NOTE: for a tighter connection, you can connect the RJ-45 plug to the AWK-4121 before STEP 4.)

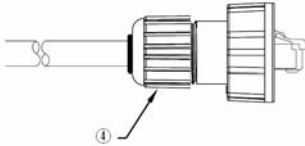

LED Indicators

The front panel of the Moxa AWK-4121 contains several LED indicators. The function of each LED is described in the table below.

LED	Color	State	Description
PWR	Green	On	Power is being supplied (from power input 1 or 2, or PoE).
		Off	Power is not being supplied
FAULT	Red	Blink (slow)	Cannot get an IP address from the DHCP server (interval: 1 sec)
		Blink (fast)	IP address conflict (interval: 0.5 sec)
		Off	Error condition does not exist.
STATE	Green/Red	Green	Software Ready
		Green Blink	The AWK has been located by AWK Search Utility. (interval: 1sec)
		Red	Booting or Error condition
WLAN	Green/Amber	Green On	WLAN functions in Client mode.
		Green Blink	WLAN's data communication is run in Client mode
		Amber On	WLAN functions in AP/Bridge mode.
		Amber Blink	WLAN's data communication is run in AP/Bridge mode
		Off	WLAN is not in use or not working properly.
LAN	Yellow/Green	Yellow On	LAN port's 10Mbps link is active.
		Yellow Blink	Data is being transmitted at 10 Mbps
		Yellow Off	LAN port's 10Mbps link is inactive.
		Green On	LAN port's 100Mbps link is active.
		Green Blink	Data is being transmitted at 100 Mbps
		Green Off	LAN port's 100Mbps link is inactive.

Specifications

WLAN

Standards

IEEE 802.11a/g/b for Wireless LAN
 IEEE 802.11i Wireless Security
 IEEE 802.3u 10/100BaseT(X) for Ethernet LAN
 IEEE 802.3af for Power-over-Ethernet
 IEEE 802.1D/w STP/RSTP

Spread Spectrum and Modulation (Typical)

DSSS with DBPSK, DQPSK, CCK
 OFDM with BPSK, QPSK, 16QAM, 64QAM

Operating Channels (Central Frequency)

US: 2.412 to 2.462 GHz (11 channels)
 5.18 to 5.24 GHz (4 channels)
 EU: 2.412 to 2.472 GHz (13 channels)
 5.18 to 5.24 GHz (4 channels)
 JP: 2.412 to 2.472 GHz (13 channels, OFDM)
 2.412 to 2.484 GHz (14 channels, DSSS)
 5.18 to 5.24 GHz (4 channels for W52)

Security	64-bit and 128-bit WEP encryption, WPA /WPA2 (IEEE 802.1X/ RADIUS ,TKIP and AES)
Protocol	General Protocols: Proxy ARP, DNS, HTTP, HTTPS, IP, ICMP, SNTP, TCP, UDP, RADIUS, SNMP, RTP AP-only Protocols: ARP, BOOTP, DHCP, dynamic VLAN-Tags for 802.1X-Clients, STP/RSTP (IEEE 802.1D/w)
Data Rates	802.11b: 1, 2, 5.5, 11 Mbps 802.11a/g: 6, 9, 12, 18, 24, 36, 48, 54 Mbps
Transmit Power	802.11b: 1 to 11 Mbps: Typ. 18±1.5 dBm 802.11g: 6 to 24 Mbps: Typ. 18±1.5 dBm 36 to 48 Mbps: Typ. 16±1.5 dBm 54 Mbps: Typ. 15±1.5 dBm 802.11a: 6 to 24 Mbps: Typ. 16±1.5 dBm 36 to 48 Mbps: Typ. 14±1.5 dBm 54 Mbps: Typ. 13±1.5 dBm
Receiver Sensitivity	802.11b: -92 dBm @ 1 Mbps, -90 dBm @ 2 Mbps, -88 dBm @ 5.5 Mbps, -84dBm @ 11 Mbps 802.11g: -87 dBm @ 6 Mbps, -86 dBm @ 9 Mbps, -85 dBm @ 12 Mbps, -82dBm @ 18 Mbps, -80 dBm @ 24 Mbps, -76 dBm @ 36 Mbps, -72dBm @ 48 Mbps, -70 dBm @ 54 Mbps 802.11a: -87 dBm @ 6 Mbps, -86 dBm @ 9 Mbps, -85 dBm @ 12 Mbps, -82dBm @ 18 Mbps, -80 dBm @ 24 Mbps, -76 dBm @ 36 Mbps, -72dBm @ 48 Mbps, -70 dBm @ 54 Mbps

Interface

Default Antenna	2.4GHz, 5dBi, Omni-directional antenna
Antenna Connector	N-type (female)
DI/DO Connection	8-pole M12 connector
Alarm Contact	1 relay output (capacity: 1A @24VDC)
Digital Input	2 electrically-isolated inputs <ul style="list-style-type: none"> • +3 to -30V for state “0” (OFF) • +13 to +30V for state “1” (ON) • Max. input current: 8 mA
Console	RS-232 (Waterproof RJ45 type)
LAN Port	10/100BaseT(X) auto negotiation speed
LED Indicators	PWR, FAULT, STATE, WLAN and LAN

Power

Input Voltage	48 VDC Power-over-Ethernet (IEEE 802.3af) or 12 to 48 VDC, redundant dual DC power inputs
Input Current	0.494A-0.121A (@12VDC-48VDC)
Input Current @ 24VDC	0.3 A
Overload Current Protection	1.6 A

Reverse Polarity Protection Present

Mechanical

Casing IP67 protection, aluminum case
Dimensions 224 x 147.7 x 66.5 mm (8.82 x 5.82 x 2.62 in)
Weight 1.2 kg
Installation Wall Mounting, or DIN-Rail mounting

Environmental

Operating Temperature -40 to 75°C (-40 to 167°F) for -T model
Storage Temperature -40 to 85°C (-40 to 185°F)
Ambient Relative Humidity 5 to 95% (non-condensing)

Regulatory Approvals*

Safety EN60950-1, UL60950-1
Radio EN300 328, EN301 893, ARIB STD-33/T66/T71 (Japan)
EMC EN301 489-1/-17, FCC Part 15, EN55022/55024, IEC61000-6-2/-4
Environmental/EMC compliancy EN50155, EN50121-1/-4

* Please check Moxa's website for the most up-to-date certification status.

WARRANTY 5 years
Details: See <http://www.moxa.com/warranty>



ATTENTION

The AWK-4121 is NOT a portable mobile device and should be located 20cm away from the human body.

The AWK-4121 is NOT designed for the general public. To deploy AWK-4121s and establish a wireless network safely, a well-trained technician is required for installation.



ATTENTION

Use the antennas correctly: The 2.4GHz antennas are needed when AWK-4121 operates in IEEE 802.11b/g. The 5GHz antennas are needed for IEEE802.11a. Make sure your antenna installation is within a safety area, which is covered by a lightning protection or surge arrest system.

Technical Support Contact Information
www.moxa.com/support

Moxa Americas:

Toll-free: 1-888-669-2872

Tel: +1-714-528-6777

Fax: +1-714-528-6778

Moxa China (Shanghai office):

Toll-free: 800-820-5036

Tel: +86-21-5258-9955

Fax: +86-10-6872-3958

Moxa Europe:

Tel: +49-89-3 70 03 99-0

Fax: +49-89-3 70 03 99-99

Moxa Asia-Pacific:

Tel: +886-2-8919-1230

Fax: +886-2-8919-1231